

FAN MOUNTING HOLE DIAMETER

28" SNAP-FAN

USE THIS GUIDE TO DETERMINE THE SIZE OF THE CUT OUT HOLE NECESSARY TO MOUNT YOUR SNAP-FAN.

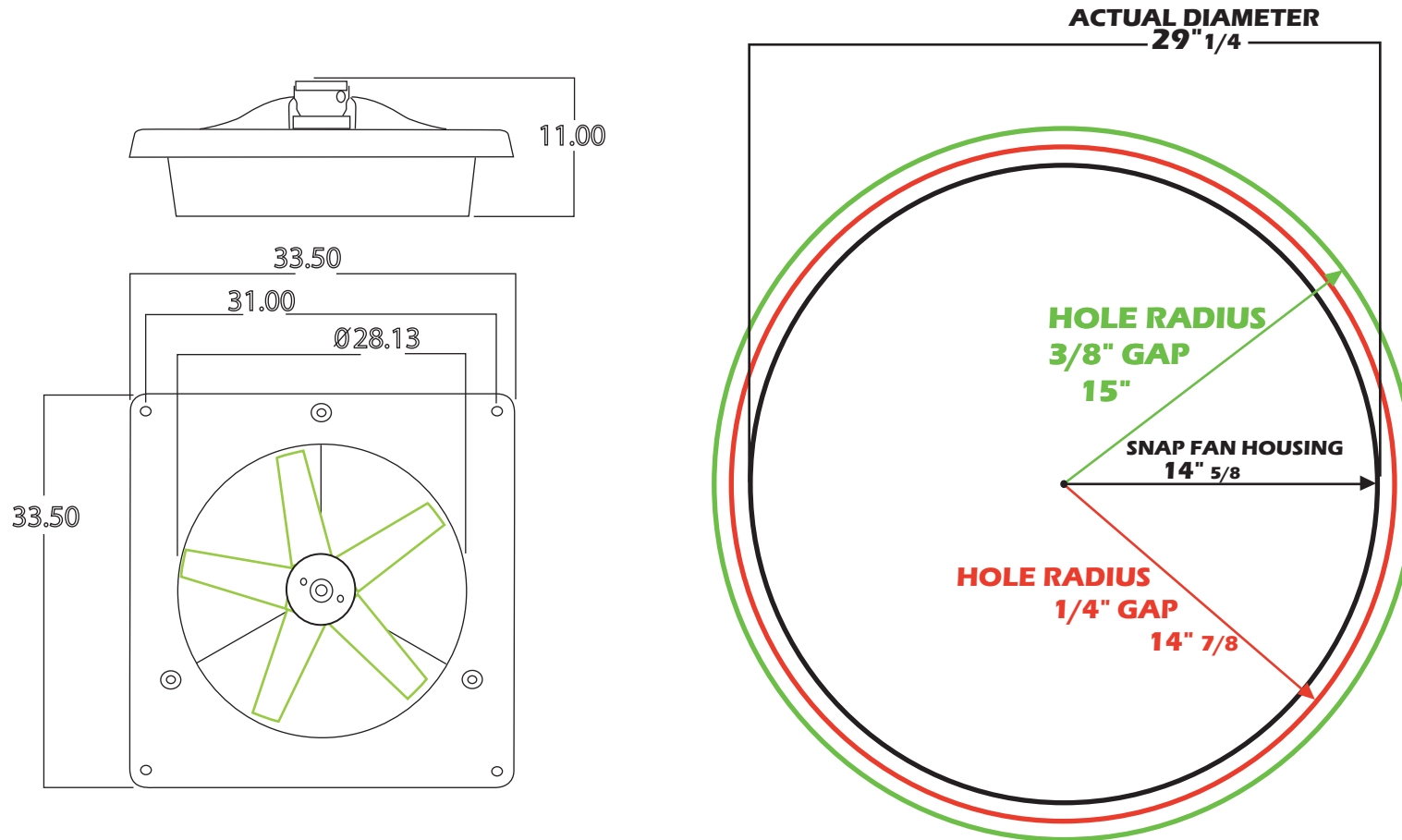

■ - Radius represents a hole 1/4" larger than the circumference of your SNAP-FAN's venturi housing

■ - Radius represents a hole 3/8" larger than the circumference of your SNAP-FAN's venturi housing